

**65V N-Ch Power MOSFET**
**Feature**

- ◇ High Speed Power Switching
- ◇ Enhanced Body diode dv/dt capability
- ◇ Enhanced Avalanche Ruggedness
- ◇ 100% UIS Tested, 100% Rg Tested
- ◇ Lead Free, Halogen Free

$V_{DS}$	65	V
$R_{DS(on),typ}$	$V_{GS}=10V$	4.1 mΩ
$I_D$ (Silicon Limited)	94	A
$I_D$ (Silicon Limited)	45	A

**Application**

- ◇ Synchronous Rectification in SMPS
- ◇ Hard Switching and High Speed Circuit
- ◇ DC/DC in Telecoms and Industrial

DFN5\*6

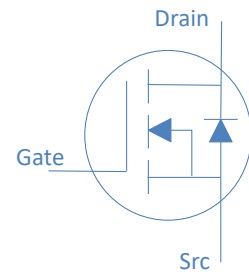
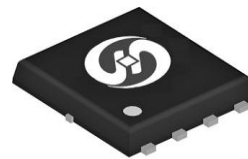

Part Number	Package	Marking
HGN046NE6A	DFN5*6	GN046NE6A

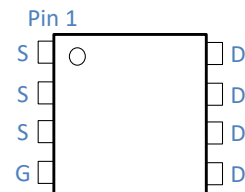
**Absolute Maximum Ratings at  $T_j=25^{\circ}C$  (unless otherwise specified)**

Parameter	Symbol	Conditions	Value	Unit
Continuous Drain Current (Silicon Limited)	$I_D$	$T_C=25^{\circ}C$	94	A
		$T_C=100^{\circ}C$	59	
		$T_C=25^{\circ}C$	45	
Continuous Drain Current (Package Limited)		$T_C=25^{\circ}C$	45	
Drain to Source Voltage	$V_{DS}$	-	65	V
Gate to Source Voltage	$V_{GS}$	-	$\pm 20$	V
Pulsed Drain Current	$I_{DM}$	-	340	A
Avalanche Energy, Single Pulse	$E_{AS}$	$L=0.1mH, T_C=25^{\circ}C$	31	mJ
Power Dissipation	$P_D$	$T_C=25^{\circ}C$	74	W
Operating and Storage Temperature	$T_J, T_{stg}$	-	-55 to 150	$^{\circ}C$

**Absolute Maximum Ratings**

Parameter	Symbol	Max	Unit
Thermal Resistance Junction-Ambient	$R_{\theta JA}$	50	$^{\circ}C/W$
Thermal Resistance Junction-Case	$R_{\theta JC}$	1.7	$^{\circ}C/W$

**Electrical Characteristics at  $T_j=25^\circ\text{C}$  (unless otherwise specified)**
**Static Characteristics**

Parameter	Symbol	Conditions	Value			Unit
			min	typ	max	
Drain to Source Breakdown Voltage	$V_{(BR)DSS}$	$V_{GS}=0V, I_D=250\mu A$	65	-	-	V
Gate Threshold Voltage	$V_{GS(th)}$	$V_{GS}=V_{DS}, I_D=250\mu A$	2.0	2.7	4.0	
Zero Gate Voltage Drain Current	$I_{DSS}$	$V_{GS}=0V, V_{DS}=60V, T_j=25^\circ\text{C}$	-	-	1	$\mu A$
		$V_{GS}=0V, V_{DS}=60V, T_j=100^\circ\text{C}$	-	-	100	
Gate to Source Leakage Current	$I_{GSS}$	$V_{GS}=\pm 20V, V_{DS}=0V$	-	-	$\pm 100$	nA
Drain to Source on Resistance	$R_{DS(on)}$	$V_{GS}=10V, I_D=20A$	-	4.1	4.6	$m\Omega$
Transconductance	$g_{fs}$	$V_{DS}=5V, I_D=20A$	-	50	-	S
Gate Resistance	$R_G$	$V_{GS}=0V, V_{DS}$ Open, $f=1\text{MHz}$	-	1.2	-	$\Omega$

**Dynamic Characteristics**

Input Capacitance	$C_{iss}$	$V_{GS}=0V, V_{DS}=30V, f=1\text{MHz}$	-	2373	-	$pF$
Output Capacitance	$C_{oss}$		-	769	-	
Reverse Transfer Capacitance	$C_{rss}$		-	45	-	
Total Gate Charge	$Q_g(10V)$	$V_{DD}=30V, I_D=20A, V_{GS}=10V$	-	41	-	$nC$
Gate to Source Charge	$Q_{gs}$		-	10	-	
Gate to Drain (Miller) Charge	$Q_{gd}$		-	10	-	
Turn on Delay Time	$t_{d(on)}$	$V_{DD}=30V, I_D=20A, V_{GS}=10V, R_G=10\Omega,$	-	11	-	$ns$
Rise time	$t_r$		-	7	-	
Turn off Delay Time	$t_{d(off)}$		-	35	-	
Fall Time	$t_f$		-	9	-	

**Reverse Diode Characteristics**

Diode Forward Voltage	$V_{SD}$	$V_{GS}=0V, I_F=30A$	-	0.9	1.2	V
Reverse Recovery Time	$t_{rr}$	$V_R=30V, I_F=20A, di_F/dt=400A/\mu s$	-	35	-	ns
Reverse Recovery Charge	$Q_{rr}$		-	88	-	nC

Fig 1. Typical Output Characteristics

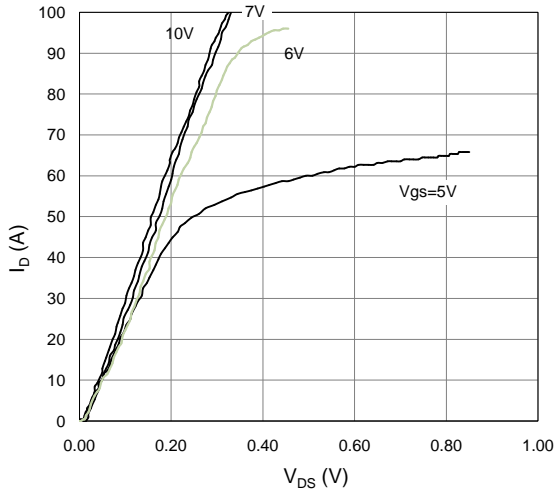

Figure 2. On-Resistance vs. Gate-Source Voltage

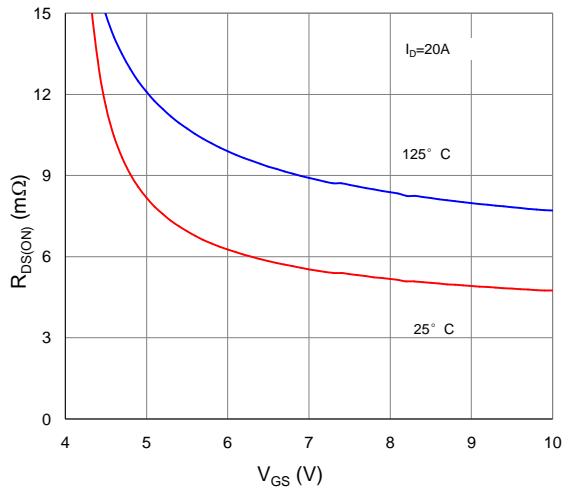

Figure 3. On-Resistance vs. Drain Current and Gate Voltage

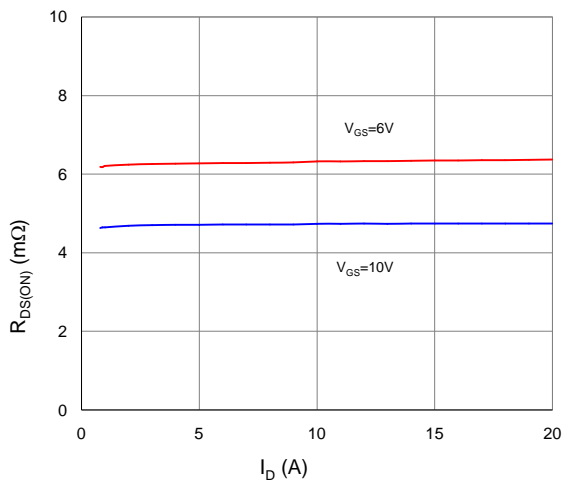

Figure 4. Normalized On-Resistance vs. Junction Temperature

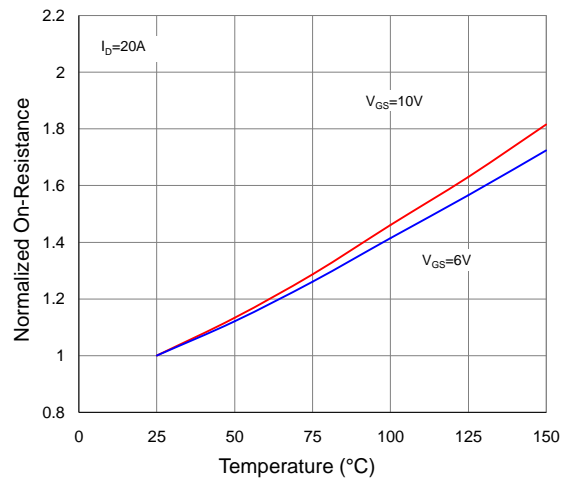

Figure 5. Typical Transfer Characteristics

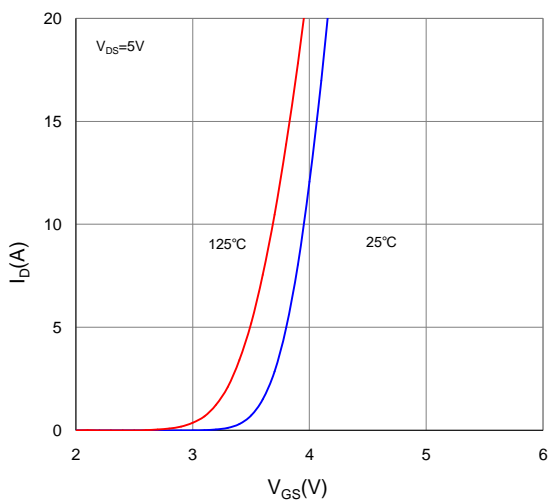

Figure 6. Typical Source-Drain Diode Forward Voltage

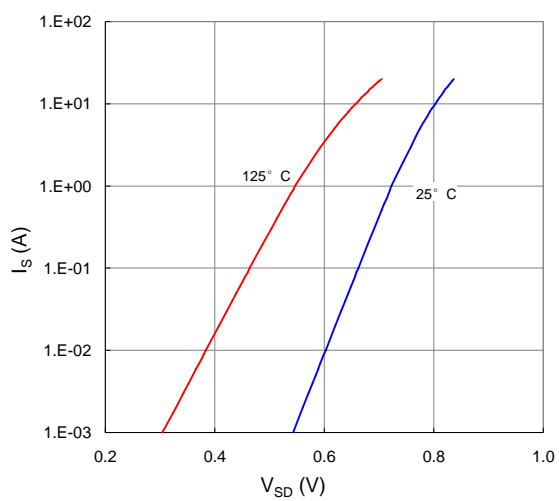

Figure 7. Typical Gate-Charge vs. Gate-to-Source Voltage

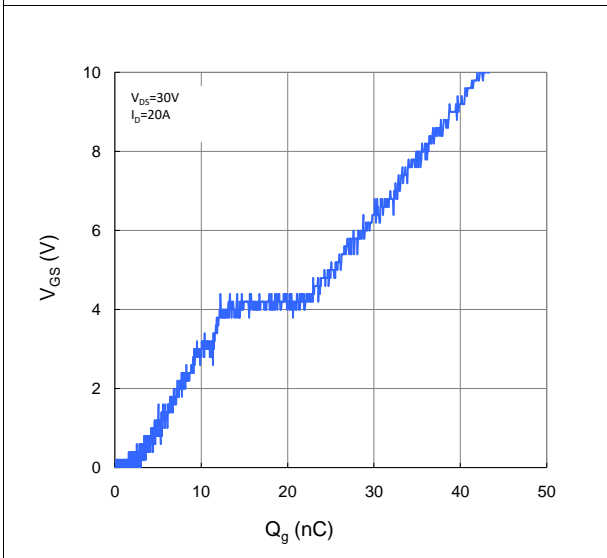

Figure 8. Typical Capacitance vs. Drain-to-Source Voltage

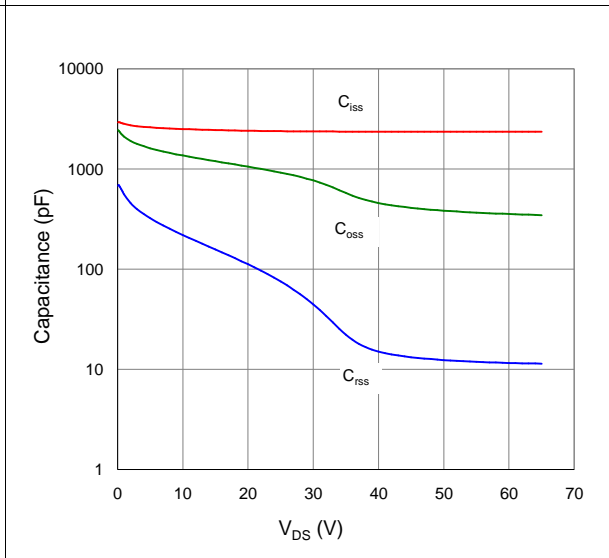

Figure 9. Maximum Safe Operating Area

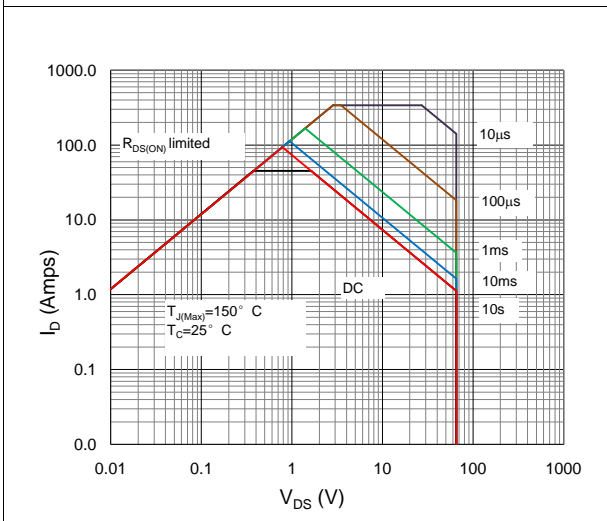

Figure 10. Maximum Drain Current vs. Case Temperature

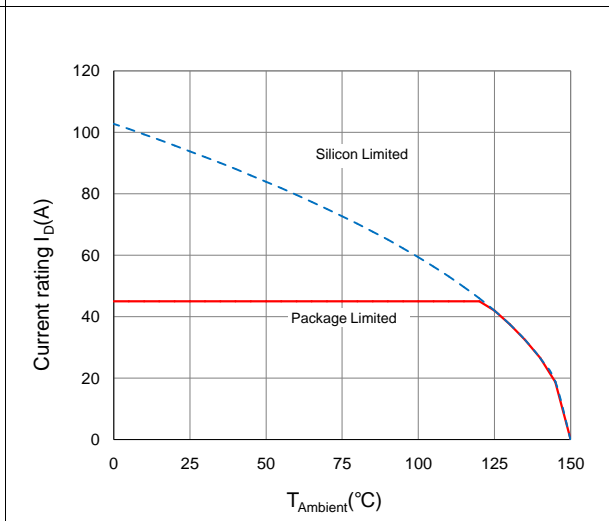
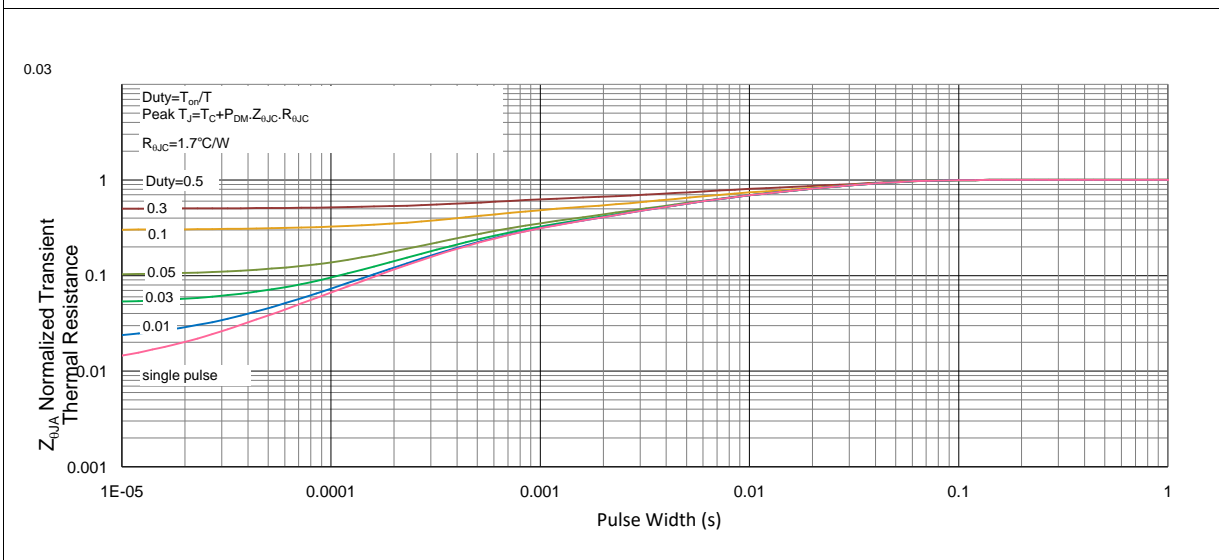
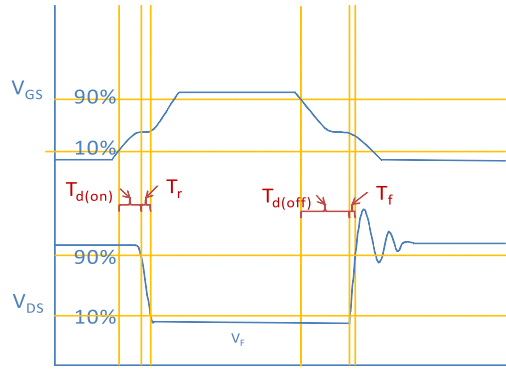
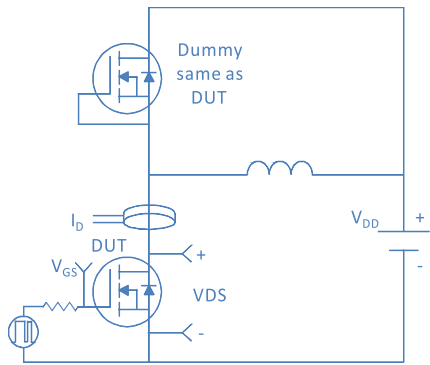

Figure 11. Normalized Maximum Transient Thermal Impedance, Junction-to-Ambient



Inductive switching Test



Gate Charge Test

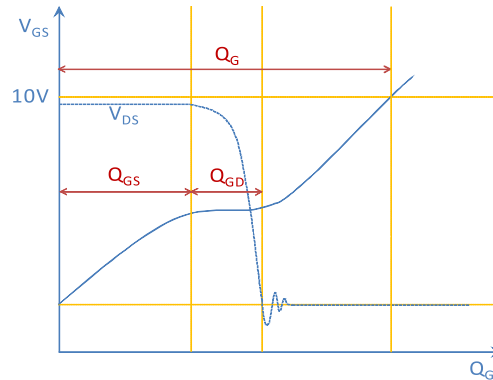
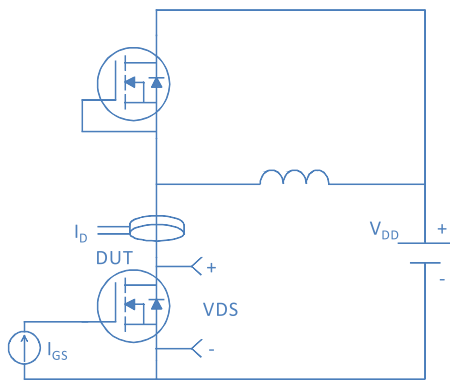

Uclamped Inductive Switching (UIS) Test

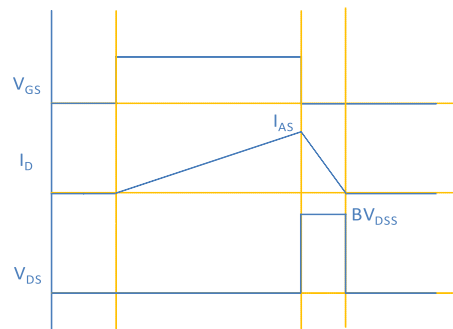
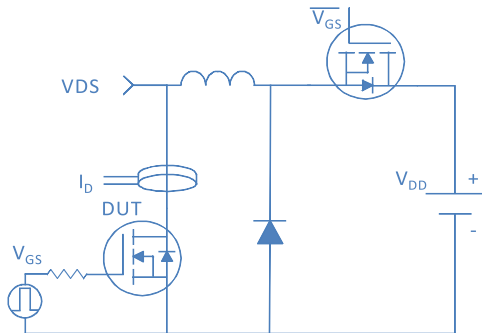

Diode Recovery Test

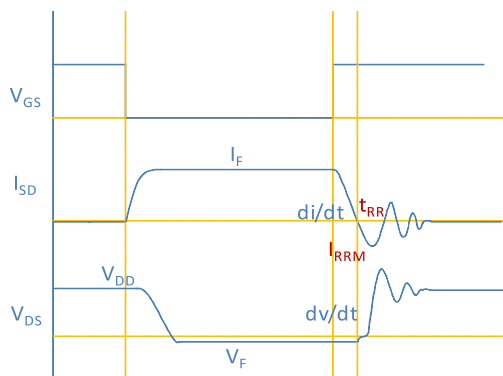
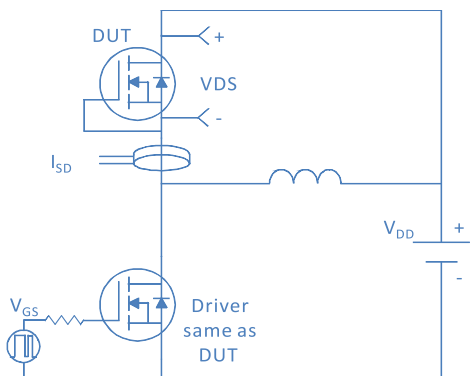

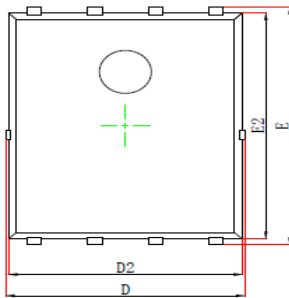
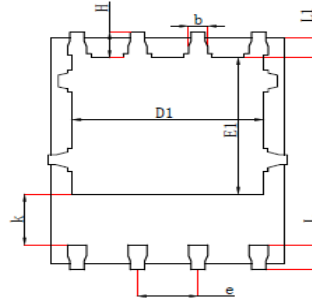
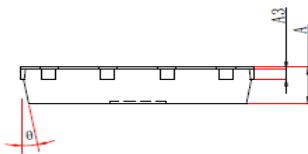
**Package Outline**
**DFN5\*6, 8 leads**

**Top View**  
 [顶视图]

**Bottom View**  
 [背视图]

**Side View**  
 [侧视图]

Symbol	Dimensions In Millimeters		Dimensions In Inches	
	Min	Max	Min	Max
A	0.900	1.100	0.035	0.043
A3	0.254 REF		0.010REF	
D	4.680	5.120	0.184	0.202
E	5.900	6.126	0.232	0.241
D1	3.610	4.110	0.142	0.162
E1	3.380	3.780	0.133	0.149
D2	4.800	5.000	0.189	0.197
E2	5.674	5.826	0.223	0.229
k	1.100	1.390	0.043	0.055
b	0.330	0.510	0.013	0.020
e	1.270TYP		1.270TYP	
L	0.510	0.711	0.020	0.028
L1	0.424	0.576	0.017	0.023
H	0.410	0.726	0.016	0.029
θ	0°	12°	0°	12°